

# Auxein

## ANKLE ARTHRODESIS NAILING SYSTEM

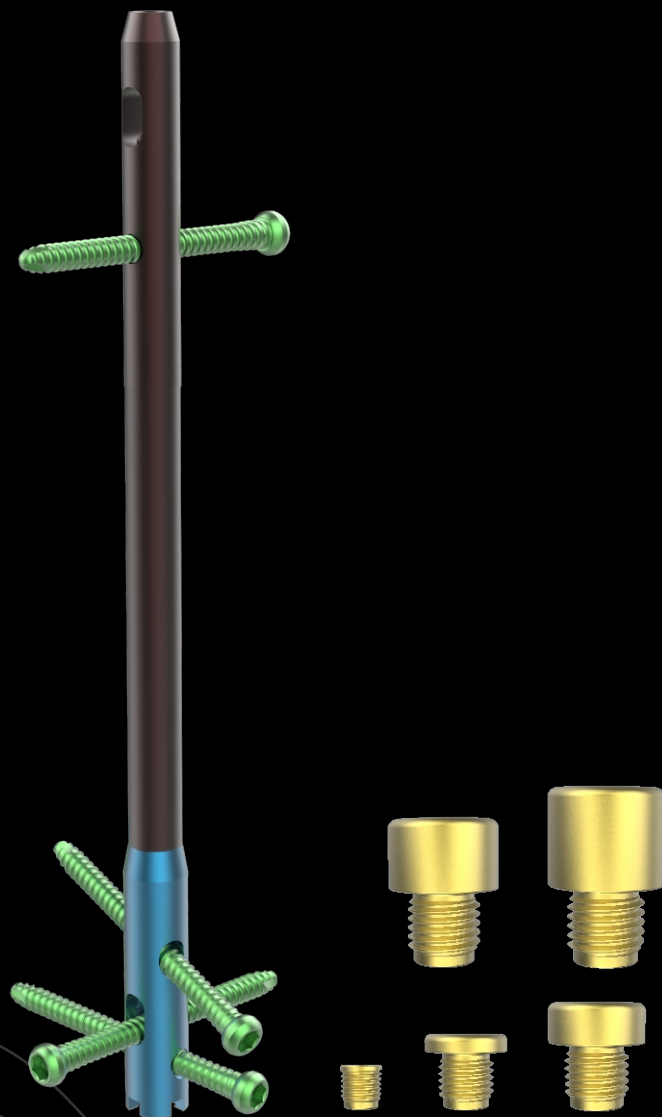

NEXT-LEVEL CARE



## ABOUT US

Auxein Medical is an integrated, research based, orthopaedic implants & instruments manufacturing company, producing a wide range of quality, affordable generic implants, trusted by healthcare professionals and patients across geographies. It is the Company's constant endeavour to provide a wide basket of generic and our innovator products that exceed the highest expectations of customers in term of quality and safety. The company has world-class manufacturing unit established in India and serves customers in over 75 countries worldwide.

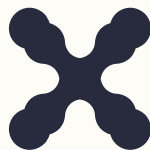

# IMPACTING HEALTHCARE GLOBALLY

Our Reach & Influence

**500+**

Employees Worldwide

**75+**

Operations in Countries

**150+**

Distributors Worldwide

**20**<sup>M+</sup>

Patients Cured

**200+**

FDA Approved Products

**250+**

Machines Worldwide

**3000+**

Innovative Orthopedic  
Products & Solutions

Auxin is dedicated to advancing medical technology through innovative orthopedic solutions, including **Trauma, Arthroscopy, and Reconstructive Procedures**, with a commitment to improving patient outcomes worldwide. Our approach integrates advanced research, precision engineering, and high-quality manufacturing to develop reliable implants and surgical instruments that address the evolving needs of modern orthopedic practice.

## OUR ACHIEVEMENTS



## OVER THE YEARS

**Disclaimer:** Not all products in this catalogue are covered by European CE, US FDA, or other certifications. Please contact our Sales Team for product-specific certification details.



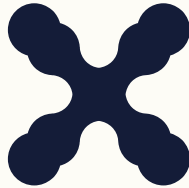

At Auxein, it is our goal to provide the best in class quality and value to every individual. Consistency is a virtue we pursue with a passion. From the procurement of raw materials to the manufacturing of our range of 1200+ orthopaedic implant products, we employ world-class systems and technology at par with the highest standards of globally recognized evaluation systems. The Ankle Arthrodesis Nailing System is part of our orthopedic portfolio designed for tibiototalcaneal (TTC) arthrodesis and hindfoot stabilization. Developed with input from global experts, the system provides reliable intramedullary fixation to support stable fusion of the ankle and hindfoot while maintaining proper anatomical alignment.



# INDEX

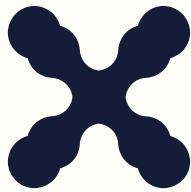

Introduction .....	11
Implants .....	12-14
Screws .....	15-17
Instruments .....	18-26
Order Information .....	27

The background of the page features a series of thin, light gray wavy lines that create a sense of movement and depth. These lines are most prominent in the top right and bottom left corners, where they form concentric, flowing patterns that resemble topographical contours or liquid ripples. The rest of the page is a plain, light gray color.

# **ANKLE ARTHRODESIS NAILING SYSTEM**



# Ankle Arthrodesis Nailing System

The **Ankle Arthrodesis Nailing System** is designed for **tibiototalcalcaneal (TTC) fusion and stabilization of the ankle and hindfoot**. Auxein's straight ankle arthrodesis nail provides reliable intramedullary fixation to support **stable fusion, proper alignment, and effective load sharing** across the ankle and subtalar joints. Engineered with high-strength materials and an optimized design, the system facilitates controlled insertion, improved rotational stability, and consistent clinical outcomes in complex ankle fusion procedures. Its comprehensive instrumentation and surgeon-friendly technique support efficient surgical workflow and reliable performance.

## Indications

- The **Ankle Arthrodesis Nailing System** is indicated for:
- **Distal tibial fractures and non-unions**
- **Severe foot and ankle deformities**
- **Degenerative osteoarthritis of the ankle joint**
- **Inflammatory arthritis** affecting the ankle or hindfoot
- **Instability and skeletal defects**, including cases following tumor resection
- **Avascular necrosis of the talus**
- **Failed ankle joint replacement or failed ankle fusion**
- **Rheumatoid arthritis and pseudoarthrosis** requiring ankle or hindfoot fusion

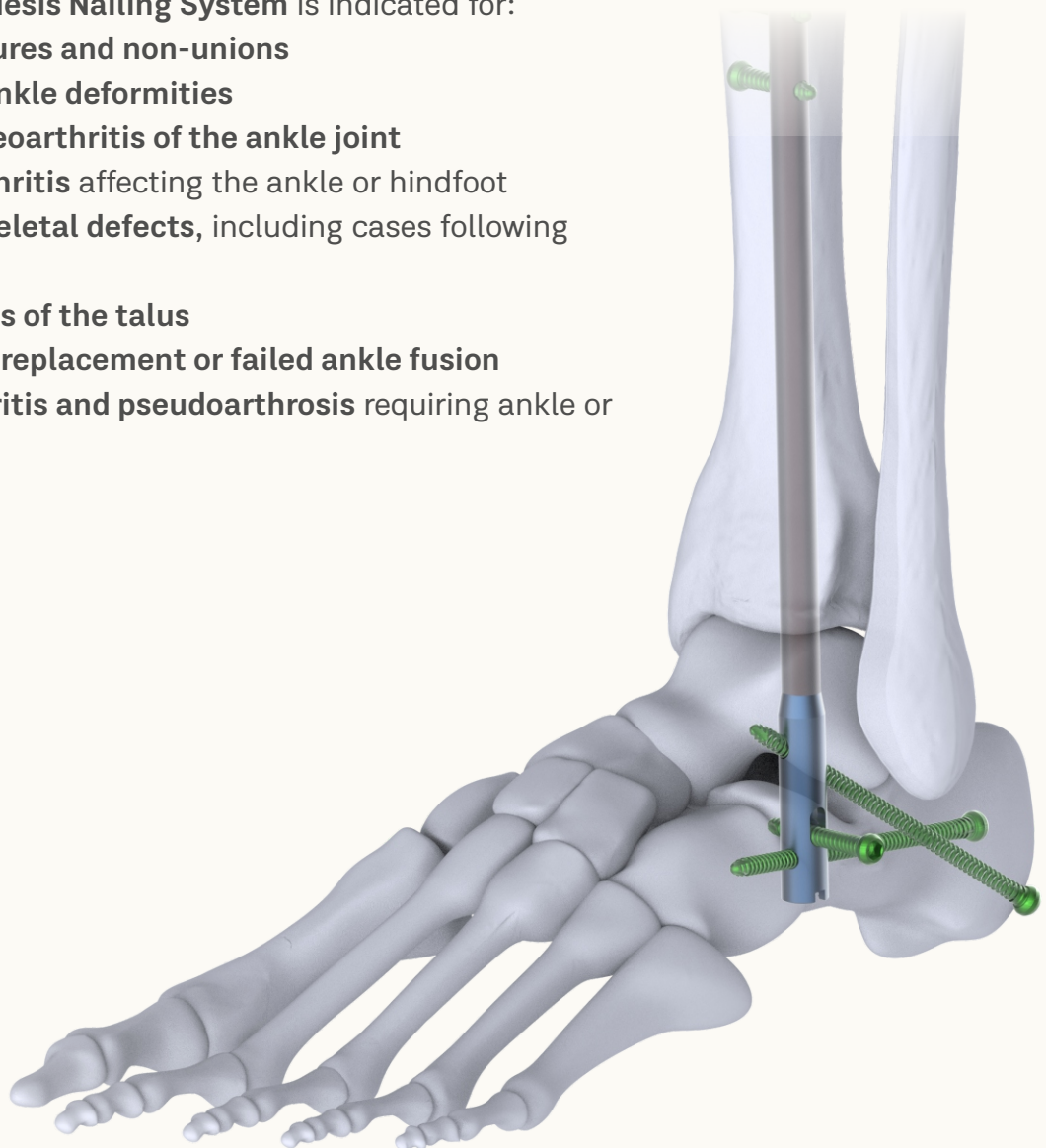



## Design Features

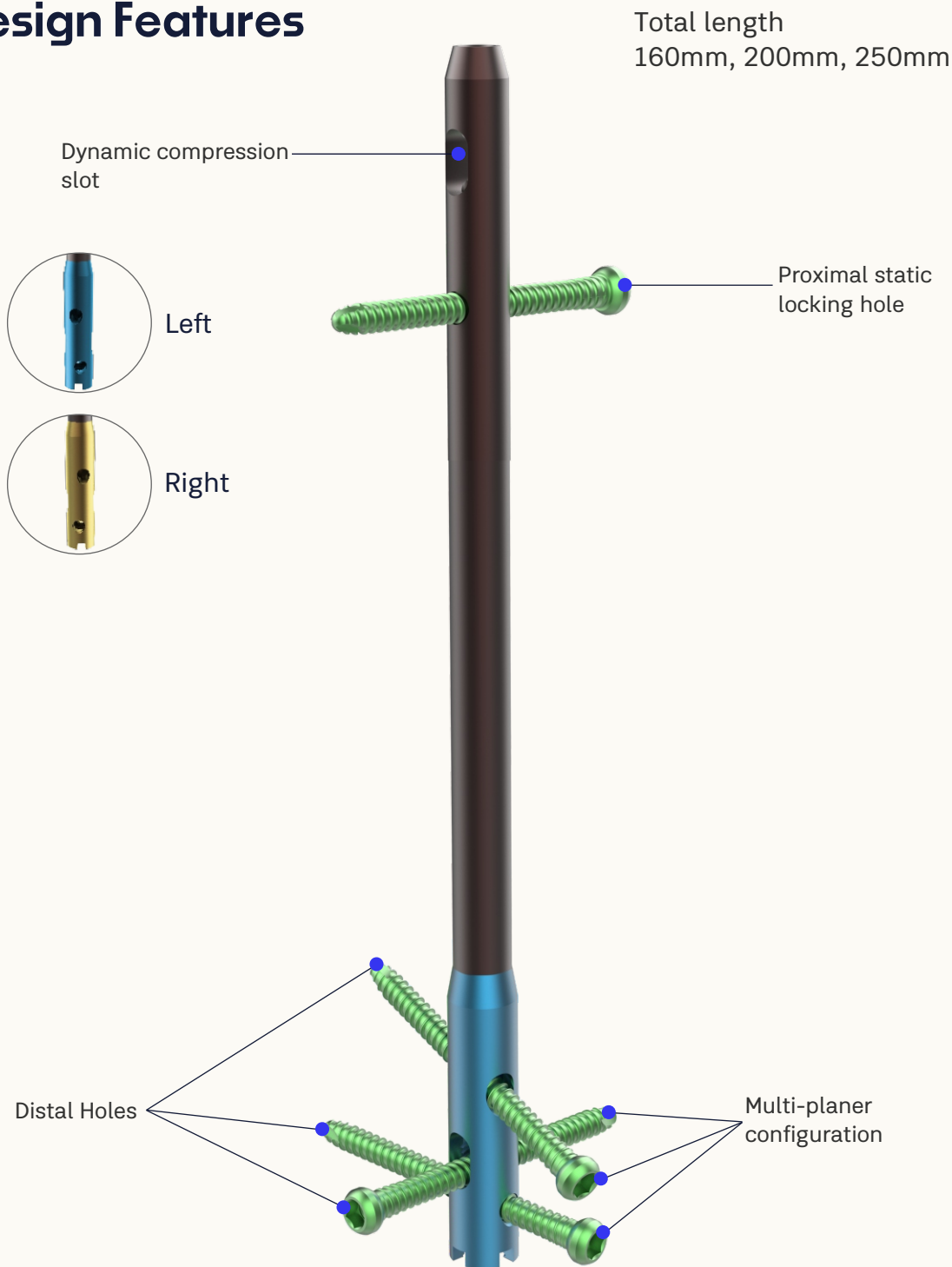

- **Static and dynamic proximal locking options** to provide flexibility based on clinical requirements.
- **Single-piece aiming arm/shaft** designed to improve locking accuracy and simplify the surgical workflow.
- **Distal sliding hole** allowing up to **5 mm controlled compression** across the fusion site.
- **Distal multi-planar screw configuration** to enhance angular stability and fixation strength.
- **Available in multiple sizes** to accommodate varying patient anatomies.
- **Left and right configurations** available for anatomical compatibility.
- **Integrated aiming arm design** helps reduce operative time while ensuring precise screw placement.

# Design Features

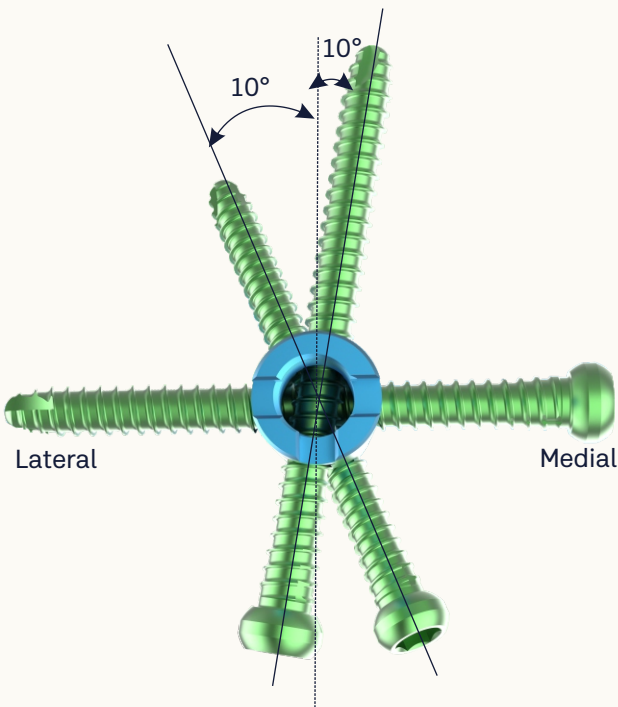
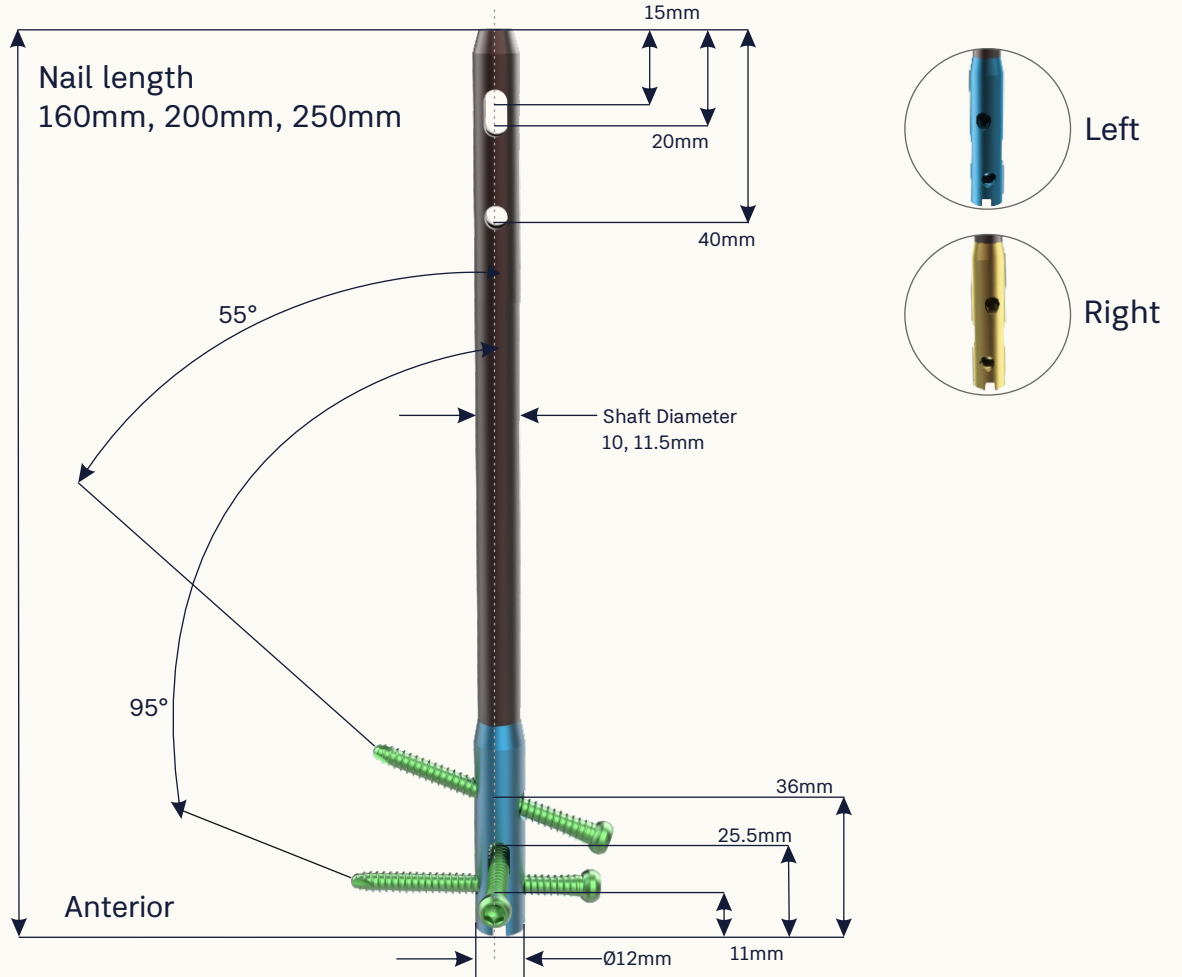



# Ankle Arthrodesis Nail, Left

**STERILE**



Dia	Length	Item Code
10mm	160mm	1-076-160LTI-S
10mm	200mm	1-076-200LTI-S
10mm	250mm	1-076-250LTI-S
11.5mm	160mm	1-083-160LTI-S
11.5mm	200mm	1-083-200LTI-S
11.5mm	250mm	1-083-250LTI-S

Dia	Length	Item Code
10mm	160mm	1-076-160LTI
10mm	200mm	1-076-200LTI
10mm	250mm	1-076-250LTI
11.5mm	160mm	1-083-160LTI
11.5mm	200mm	1-083-200LTI
11.5mm	250mm	1-083-250LTI



Left



Right

# Ankle Arthrodesis Nail, Right

**STERILE**



Dia	Length	Item Code
10mm	160mm	1-076-160RTI-S
10mm	200mm	1-076-200RTI-S
10mm	250mm	1-076-250RTI-S
11.5mm	160mm	1-083-160RTI-S
11.5mm	200mm	1-083-200RTI-S
11.5mm	250mm	1-083-250RTI-S

Dia	Length	Item Code
10mm	160mm	1-076-160RTI
10mm	200mm	1-076-200RTI
10mm	250mm	1-076-250RTI
11.5mm	160mm	1-083-160RTI
11.5mm	200mm	1-083-200RTI
11.5mm	250mm	1-083-250RTI



# SCREWS



# 5.0mm Locking Bolt for Ankle Arthrodesis Nail (Hex Head)

**STERILE**



Dia	Length	Item Code
5.0mm	26mm	1-086-26TI-S
5.0mm	28mm	1-086-28TI-S
5.0mm	30mm	1-086-30TI-S
5.0mm	32mm	1-086-32TI-S
5.0mm	34mm	1-086-34TI-S
5.0mm	36mm	1-086-36TI-S
5.0mm	38mm	1-086-38TI-S
5.0mm	40mm	1-086-40TI-S
5.0mm	42mm	1-086-42TI-S
5.0mm	44mm	1-086-44TI-S
5.0mm	46mm	1-086-46TI-S
5.0mm	48mm	1-086-48TI-S
5.0mm	50mm	1-086-50TI-S
5.0mm	52mm	1-086-52TI-S
5.0mm	54mm	1-086-54TI-S
5.0mm	56mm	1-086-56TI-S
5.0mm	58mm	1-086-58TI-S
5.0mm	60mm	1-086-60TI-S
5.0mm	62mm	1-086-62TI-S
5.0mm	64mm	1-086-64TI-S
5.0mm	66mm	1-086-66TI-S
5.0mm	68mm	1-086-68TI-S
5.0mm	70mm	1-086-70TI-S
5.0mm	72mm	1-086-72TI-S
5.0mm	74mm	1-086-74TI-S
5.0mm	76mm	1-086-76TI-S
5.0mm	78mm	1-086-78TI-S
5.0mm	80mm	1-086-80TI-S
5.0mm	85mm	1-086-85TI-S
5.0mm	90mm	1-086-90TI-S
5.0mm	95mm	1-086-95TI-S
5.0mm	100mm	1-086-100TI-S
5.0mm	105mm	1-086-105TI-S
5.0mm	110mm	1-086-110TI-S

Dia	Length	Item Code
5.0mm	26mm	1-086-26TI
5.0mm	28mm	1-086-28TI
5.0mm	30mm	1-086-30TI
5.0mm	32mm	1-086-32TI
5.0mm	34mm	1-086-34TI
5.0mm	36mm	1-086-36TI
5.0mm	38mm	1-086-38TI
5.0mm	40mm	1-086-40TI
5.0mm	42mm	1-086-42TI
5.0mm	44mm	1-086-44TI
5.0mm	46mm	1-086-46TI
5.0mm	48mm	1-086-48TI
5.0mm	50mm	1-086-50TI
5.0mm	52mm	1-086-52TI
5.0mm	54mm	1-086-54TI
5.0mm	56mm	1-086-56TI
5.0mm	58mm	1-086-58TI
5.0mm	60mm	1-086-60TI
5.0mm	62mm	1-086-62TI
5.0mm	64mm	1-086-64TI
5.0mm	66mm	1-086-66TI
5.0mm	68mm	1-086-68TI
5.0mm	70mm	1-086-70TI
5.0mm	72mm	1-086-72TI
5.0mm	74mm	1-086-74TI
5.0mm	76mm	1-086-76TI
5.0mm	78mm	1-086-78TI
5.0mm	80mm	1-086-80TI
5.0mm	85mm	1-086-85TI
5.0mm	90mm	1-086-90TI
5.0mm	95mm	1-086-95TI
5.0mm	100mm	1-086-100TI
5.0mm	105mm	1-086-105TI
5.0mm	110mm	1-086-110TI

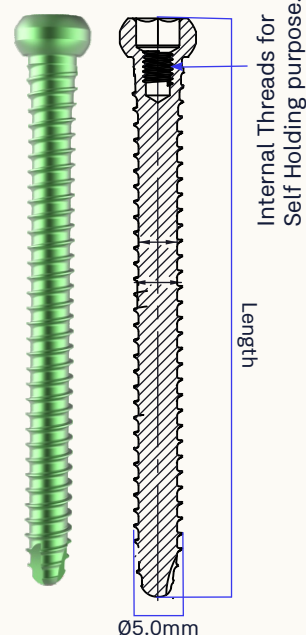
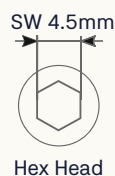

# End Cap for Ankle Arthrodesis Nail

**STERILE**

Length	Item Code
0 mm	1-084-01TI-S
2.5mm	1-084-02TI-S
5.0mm	1-084-03TI-S
7.5mm	1-084-04TI-S
10.0mm	1-084-05TI-S

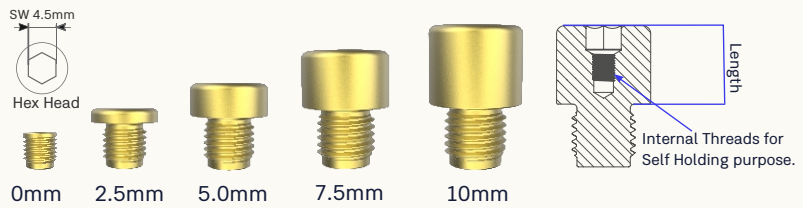

Length	Item Code
0 mm	1-084-01TI
2.5mm	1-084-02TI
5.0mm	1-084-03TI
7.5mm	1-084-04TI
10.0mm	1-084-05TI

# Compression Screw for Ankle Arthrodesis Nail (Hex Head), Titanium

Compression nut in distal sliding hole allows 5 mm compression

**STERILE**

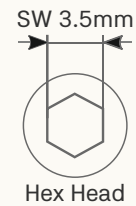

Item Code
1-085-01TI-S

Item Code
1-085-01TI



# **INSTRUMENTS**



7-174-01

Radiographic Ruler For Ankle Arthrodesis Nailing Instrument



7-174-02

Guide Wire With Threaded Tip  $\varnothing 3.2\text{mm}$  X Thread Length 10.0mm X Length 300mm



7-174-03

Guide Wire With Threaded Tip  $\varnothing 3.2\text{mm}$  X Thread Length 10.0mm X Length 345mm



7-174-04

Entry Reamer Protection Sleeve  $\varnothing 15/12.5\text{mm}$  For Ankle Arthrodesis Nailing Instrument



7-174-05

Guide Wire Sleeve  $\varnothing 12.5/3.2\text{mm}$  For Ankle Arthrodesis Nailing Instrument



7-174-06

Cannulated Awl For Ankle Arthrodesis Nailing Instrument





7-174-07

Cannulated Entry Reamer  $\text{\O}12.5 / \text{\O}3.2\text{mm}$  For Ankle Arthrodesis Nailing Instrument



7-174-08

Adaptor With Jacob Coupling For Ankle Arthrodesis Nailing Instrument



7-174-09

T- Handle With Jacob Coupling For Ankle Arthrodesis Nailing Instrument



7-174-10

Reduction Device For Ankle Arthrodesis Nailing Instrument



7-174-11

Guide Wire Interducer For Ankle Arthrodesis Nailing Instrument



7-174-12

Guide Wire With Ball Tip  $\text{\O}2.5/4.0\text{mm}$  X Length 680mm, Nitinol For Ankle Arthrodesis Nailing Instrument

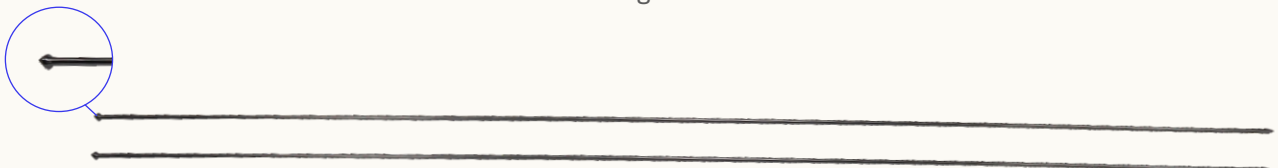



7-174-13

Flexible Reamer With Shaft Ø9mm For Ankle Arthrodesis Nailing Instrument



7-174-14

Flexible Reamer With Shaft Ø10mm For Ankle Arthrodesis Nailing Instrument



7-174-15

Flexible Reamer With Shaft Ø11mm For Ankle Arthrodesis Nailing Instrument



7-174-16

Flexible Reamer With Shaft Ø12mm For Ankle Arthrodesis Nailing Instrument



7-174-17

Flexible Reamer With Shaft Ø13mm For Ankle Arthrodesis Nailing Instrument



7-174-18

Insertion Handle For Ankle Arthrodesis Nailing Instrument

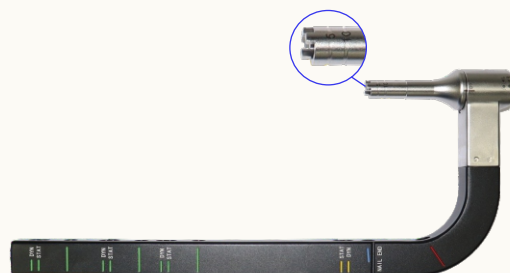



7-174-19

Nail Holding Bolt (M8x1) For Ankle Arthrodesis Nailing Instrument



7-174-20

Wrench SW11 For Ankle Arthrodesis Nailing Instrument



7-174-21

Cannulated Impactor-Extractor Rod (M8x1) For Ankle Arthrodesis Nailing Instrument



7-174-22

Sliding Hammer For Ankle Arthrodesis Nailing Instrument



7-174-23

Outer Protection Sleeve  $\varnothing 10/8.0\text{mm}$ , Length 155mm For Ankle Arthrodesis Nailing Instrument



7-174-24

Drill Sleeve  $\varnothing 8.0 / \varnothing 4.0\text{mm}$ , length 170mm For Ankle Arthrodesis Nailing Instrument





7-174-25

Trocar Ø4.0 X 186mm Length For Ankle Arthrodesis Nailing Instrument

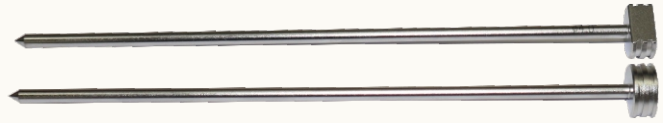

7-174-26

Drill Bit With Jacob Coupling, Ø4.0mm X Length 300mm For Ankle Arthrodesis Nailing Instrument



7-174-27

Stopper For Ø4.0mm Drill Bit



7-174-28

Allen Key, Hex 3mm For Ankle Arthrodesis Nailing Instrument



7-174-29

Depth Gauge Upto 110mm For Ankle Arthrodesis Nailing Instrument



7-174-30

T-handle Screwdriver, SW4.5 For Ankle Arthrodesis Nailing Instrument





7-174-31

Inner Threaded Bar, M3 For T-handle Screwdriver



7-174-32

Hex Screwdriver Shaft, SW4.5 With Jacob Coupling For Ankle Arthrodesis Nailing Instrument



7-174-33

Hex Screwdriver, SW3.5 For Ankle Arthrodesis Nailing Instrument



7-174-34

Implant Tray For Ankle Arthrodesis Nailing Instrument

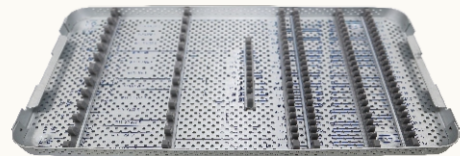

7-174-35

Instrument Tray-I For Ankle Arthrodesis Nailing Instrument

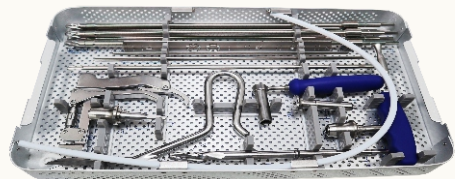

7-174-37

Container with Lid for Ankle Arthrodesis Nailing Instrument





**7-174 : Ankle Arthrodesis Nailing Instruments Set**

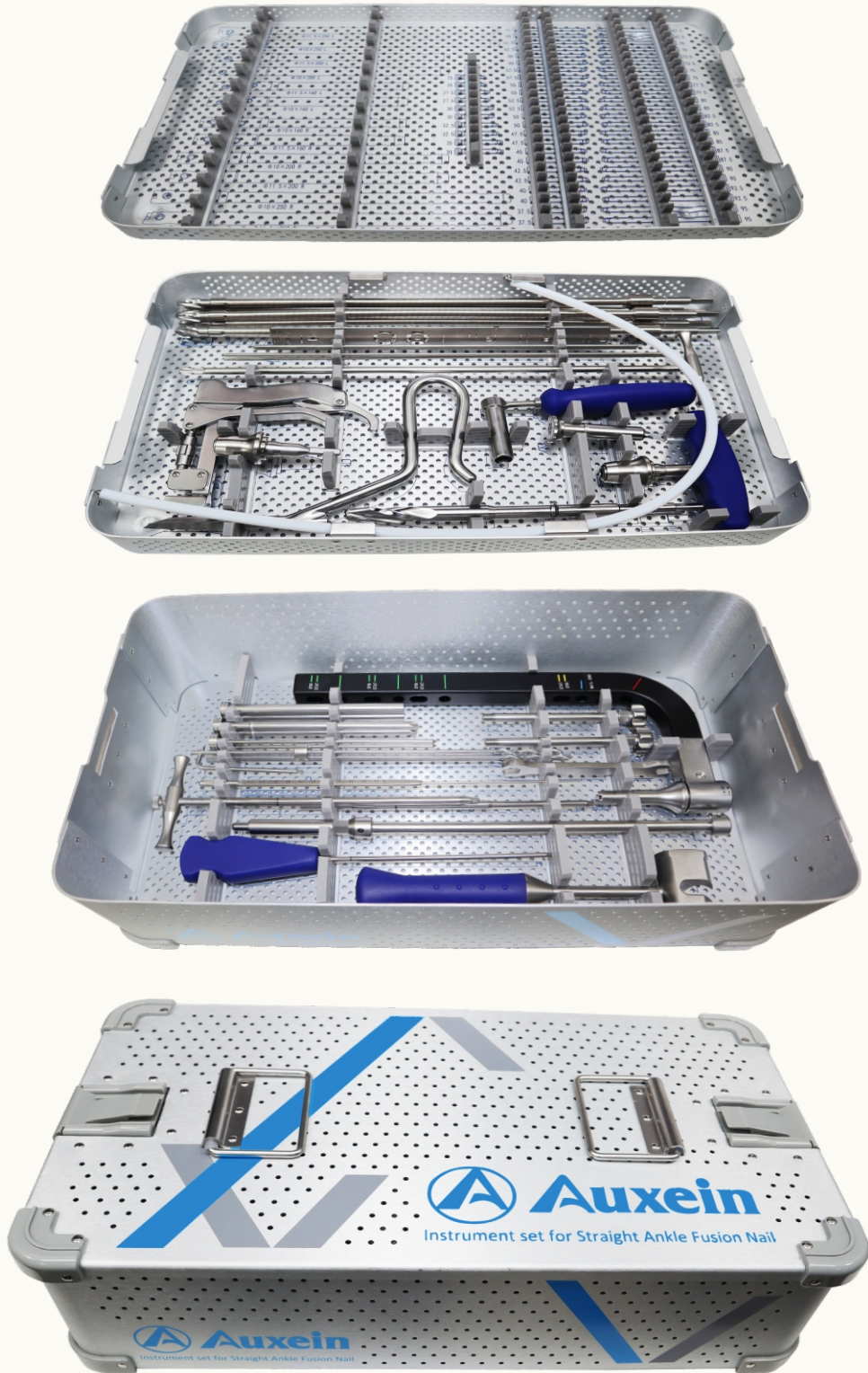



# ORDER INFORMATION

7-174

## Ankle Arthrodesis Nailing Instrument Set

Code	Set Consisting Of	Unit
7-174-01	Radiographic Ruler for Ankle Arthrodesis Nailing Instrument	1
7-174-02	Guide Wire with Threaded Tip Ø3.2mm x Thread Length 10.0mm X Length 300mm	2
7-174-03	Guide Wire with Threaded Tip Ø3.2mm x Thread Length 10.0mm X Length 345mm	2
7-174-04	Entry Reamer Protection Sleeve Ø15/12.5mm for Ankle Arthrodesis Nailing Instrument	1
7-174-05	Guide Wire Sleeve ØØ12.5/3.2mm for Ankle Arthrodesis Nailing Instrument	1
7-174-06	Cannulated Awl for Ankle Arthrodesis Nailing Instrument	1
7-174-07	Cannulated Entry Reamer Ø12.5 / Ø3.2mm for Ankle Arthrodesis Nailing Instrument	1
7-174-08	Adaptor with Jacob Coupling for Ankle Arthrodesis Nailing Instrument	1
7-174-09	T- Handle with Jacob Coupling for Ankle Arthrodesis Nailing Instrument	1
7-174-10	Reduction Device for Ankle Arthrodesis Nailing Instrument	1
7-174-11	Guide Wire Interducer for Ankle Arthrodesis Nailing Instrument	1
7-174-12	Guide Wire with Ball Tip Ø2.5/4.0mm x Length 680mm, Nitinol	2
7-174-13	Flexible Reamer with Shaft Ø9mm for Ankle Arthrodesis Nailing Instrument	1
7-174-14	Flexible Reamer with Shaft Ø10mm for Ankle Arthrodesis Nailing Instrument	1
7-174-15	Flexible Reamer with Shaft Ø11mm for Ankle Arthrodesis Nailing Instrument	1
7-174-16	Flexible Reamer with Shaft Ø12mm for Ankle Arthrodesis Nailing Instrument	1
7-174-17	Flexible Reamer with Shaft Ø13mm for Ankle Arthrodesis Nailing Instrument	1
7-174-18	Insertion Handle for Ankle Arthrodesis Nailing Instrument	1
7-174-19	Nail Holding Bolt (M8x1) for Ankle Arthrodesis Nailing Instrument	2
7-174-20	Wrench SW11 for Ankle Arthrodesis Nailing Instrument	1
7-174-21	Cannulated Impactor-Extractor Rod (M8x1) for Ankle Arthrodesis Nailing Instrument	1
7-174-22	Sliding Hammer for Ankle Arthrodesis Nailing Instrument	1
7-174-23	Outer Protection Sleeve Ø10/8.0mm, Length 155mm for Ankle Arthrodesis Nailing Instrument	2
7-174-24	Drill Sleeve Ø8.0/4.0mm, Length 170mm for Ankle Arthrodesis Nailing Instrument	2
7-174-25	Trocar Ø4.0 x 186mm Length for Ankle Arthrodesis Nail	2
7-174-26	Drill Bit with Jacob Coupling, Ø4.0mm x Length 300mm for Ankle Arthrodesis Nail	1
7-174-27	Stopper for Ø4.0mm Drill bit	1
7-174-28	Allen Key, Hex 3mm for Ankle Arthrodesis Nailing Instrument	1
7-174-29	Depth Gauge upto 110mm for Ankle Arthrodesis Nailing Instrument	1
7-174-30	T-Handle Screwdriver, SW4.5 for Ankle Arthrodesis Nailing Instrument	1
7-174-31	Inner Threaded Bar, M3 for T-Handle Screwdriver	1
7-174-32	Hex Screwdriver Shaft, SW4.5 with Jacob Coupling for Ankle Arthrodesis Nailing Instrument	1
7-174-33	Hex Screwdriver, SW3.5 for Ankle Arthrodesis Nailing Instrument	1
7-174-34	Implant Tray for Ankle Arthrodesis Nailing Instrument	1
7-174-35	Instrument Tray-I for Ankle Arthrodesis Nailing Instrument	1
7-174-37	Container with Lid for Ankle Arthrodesis Nailing Instrument	1



## **ANKLE ARTHRODESIS NAILING SYSTEM**

The content of this catalogue is intended for healthcare professionals only. All product information, illustrations, descriptions, and specifications provided here are for general informational purposes and are subject to change without notice. Auxein Medical Pvt. Ltd. reserves the right to improve or discontinue products at any time without prior notification.

This document does not constitute medical advice. Surgeons and medical practitioners must exercise their own professional judgment when using any medical devices or instruments, including those provided by Auxein.

### **CLINICAL USE**

The implants and instruments in this catalogue are intended for use by qualified orthopedic trauma surgeons trained in fracture fixation and intramedullary nailing procedures. Improper selection of the implant, incorrect surgical technique, misuse, or insufficient surgical experience may result in implant failure or other complications.

### **REGULATORY COMPLIANCE CERTIFIED**

ISO 13485:2016

CDSCO

MDSAP

**DISCLAIMER:** Not all products in this catalogue are covered by European CE, US FDA, or other certifications. Please contact our Sales Team for product-specific certification details.

### **INTELLECTUAL PROPERTY**

All trademarks, trade names, brand names, product names, and logos mentioned in this catalogue are the property of Auxein Medical Pvt. Ltd. Unauthorized use or reproduction is strictly prohibited.

V1-2026



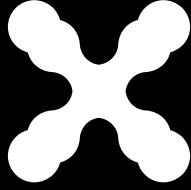

SCAN TO KNOW MORE

**INDIA**  
**AUXEIN MEDICAL PVT.LTD.**

PLOT NO. 168-169-170, PHASE-4,  
KUNDLI INDUSTRIAL AREA,  
HSIIDC, SECTOR-57,  
SONEPAT-131028, HARYANA  
TEL: +91 99106 43638  
FAX: +91 86077 70197  
EMAIL: INFO@AUXEIN.COM

**MÉXICO**  
**AUXEIN MÉXICO, S.A DE CV**

TEPIC 39 INT 801, COLONIA  
ROMA SUR,  
ALCADÍA CUAUHTÉMOC, CDMX  
MÉXICO, C.P 06760  
TEL: +521 55 7261 0318  
EMAIL: INFO@AUXEIN.MX

**USA**  
**AUXEIN INC.**

1500 NW 89TH COURT,  
SUITE 107-108  
DORAL, FLORIDA 33172  
TEL. +1 305 395 6062  
E FAX: +1 305 395 62 62  
EMAIL: USOFFICE@AUXEIN.COM

**DUBAI UAE**  
**AUXEIN MEDICAL**

TRADING FZCO OUD METHA  
OFFICES BUILDING B BLOCK,  
1ST FLOOR, OFFICE NO.26,  
NEAR HEALTHCARE CITY,  
PO BOX-25572  
TEL. +971 438 71333  
EMAIL: INFO@AUXEIN.COM

[WWW.AUXEIN.COM](http://WWW.AUXEIN.COM)