

# Auxein

## EXPERT FEMUR NAILING SYSTEM





## ABOUT US

Auxein Medical is an integrated, research based, orthopaedic implants & instruments manufacturing company, producing a wide range of quality, affordable generic implants, trusted by healthcare professionals and patients across geographies. It is the Company's constant endeavour to provide a wide basket of generic and our innovator products that exceed the highest expectations of customers in term of quality and safety. The company has world-class manufacturing unit established in India and serves customers in over 75 countries worldwide.

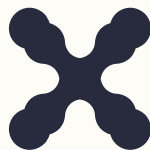

# IMPACTING HEALTHCARE GLOBALLY

Our Reach & Influence

**500+**

Employees Worldwide

**75+**

Operations in Countries

**150+**

Distributors Worldwide

**20**<sup>M+</sup>

Patients Cured

**200+**

FDA Approved Products

**250+**

Machines Worldwide

**3000+**

Innovative Orthopedic  
Products & Solutions

Auxin is dedicated to advancing medical technology through innovative orthopedic solutions, including **Trauma, Arthroscopy, and Reconstructive Procedures**, with a commitment to improving patient outcomes worldwide. Our approach integrates advanced research, precision engineering, and high-quality manufacturing to develop reliable implants and surgical instruments that address the evolving needs of modern orthopedic practice.

# OUR ACHIEVEMENTS



OVER THE YEARS



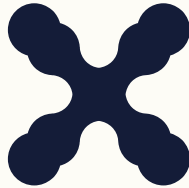

At Auxein, it is our goal to provide the best in class quality and value to every individual. Consistency is a virtue we pursue with a passion. From the procurement of raw materials to the manufacturing of our range of 1200+ orthopaedic implant products, we employ world-class systems and technology at par with the highest standards of globally recognized evaluation systems. The Expert Femur Nailing System is part of our advanced orthopedic portfolio designed to support versatile fixation techniques in trauma and reconstructive procedures. Developed with input from global experts, the system provides reliable solutions for fixation of for intramedullary fixation of femoral fractures, helping achieve stable fixation and accurate anatomical alignment.



# INDEX

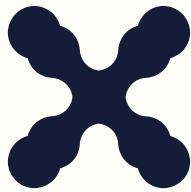

Introduction & Indications .....	11-15
Implants & Caddy .....	16-27
Instruments .....	28-42
Order Information .....	43-44



# **EXPERT FEMUR NAILING SYSTEM**



# EXPERT FEMUR NAILING SYSTEM

## INTRODUCTION

The Expert Femur Nail enables the surgeon to stabilize low and extended subtrochanteric femur fractures, ipsilateral neck/shaft fractures, femur shaft fractures, impending pathological fractures, malunions and nonunions.

## LOCKING OPTIONS

### Standard Locking

The Expert Femur Nail with standard locking is indicated for fractures in femur shaft (except subtrochanteric fractures).



For sufficient proximal static locking, always use the 120° antegrade locking option together with the transverse static screw.



- For immediate **primary dynamization**, insert only one proximal locking screw through the dynamic slot.



- For **secondary dynamization** use both the dynamic and the 120° antegrade locking position and remove the 120° locking when required.



**INDICATIONS**

**Standard Locking Indications**

The Expert Femur Nail with standard locking is indicated for fractures in the Femur Shaft:

32-A/B/C (except subtrochanteric fractures  
32-A [1-3].1, 32-B [1-3].1, and 32-C [1-3].1).



**Reconstruction Locking Indications**

The Expert Femur Nail with reconstruction locking is indicated for fractures in the femur shaft in case of combination with femur neck fractures:

32-A/B/C combined with 31-B (double ipsilateral fractures).  
Additionally the Expert Femur Nail is indicated for fractures in the subtrochanteric section:  
32-A [1-3].1, 32-B [1-3].1, and 32-C [1-3].1.

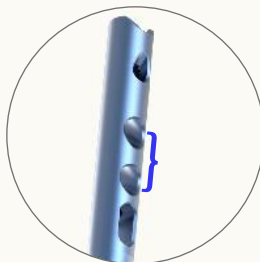

Ø6.4mm Cannulated Anti-Rotation screws

**Contraindications**

- Isolated femur neck fractures.
- Supracondylar fractures (localisation 32).
- Intertrochanteric fractures
- Pertrochanteric fractures

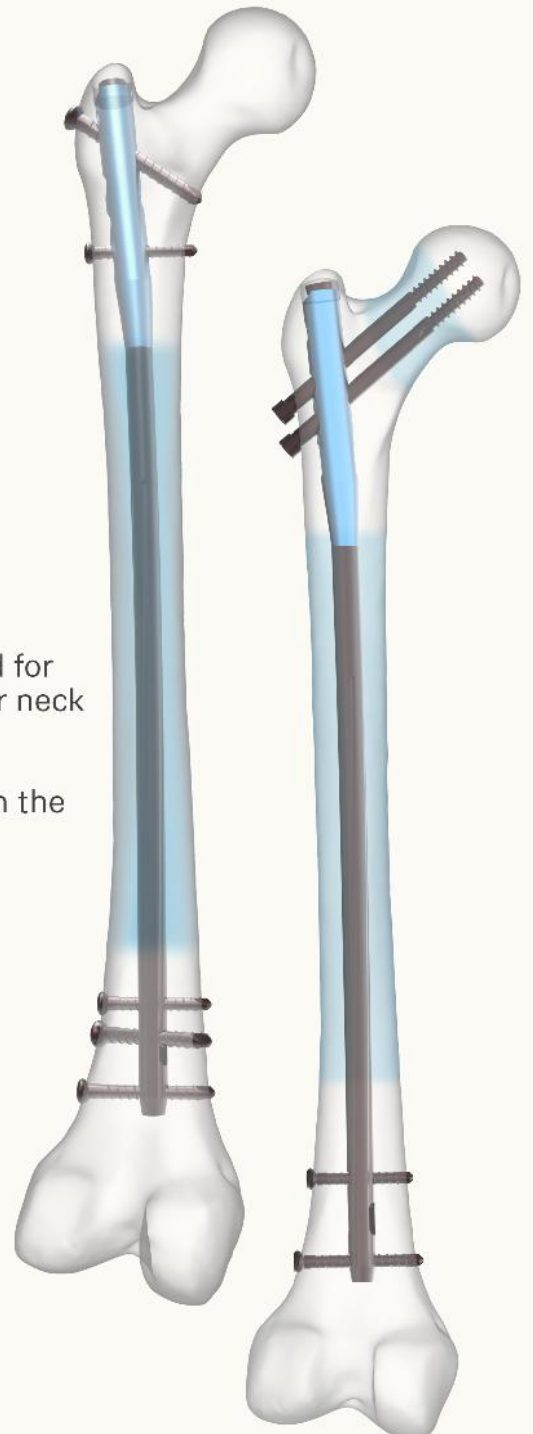



**PRODUCT SPECIFICATIONS**

**Expert Femur Nail**

**Length:**

320mm - 440mm (With 20mm difference)

**Diameters:**

Ø9mm, Ø10mm, Ø11mm, Ø12mm & Ø13mm

**Proximal end :** Ø13.5mm

**Available in:**

Stainless Steel and Titanium

**Directions:**

Left and Right

Proximal End : 3 holes slot

Distal End : 3 holes Slot

(2 Locking slot and 1 dynamic slot)



Right  
Golden & Type-II



Left  
Blue & Type-II

**Color Coding (only for Titanium):**

Expert Femur Nail, Left - Blue & Type-II

Expert Femur Nail, Right - Golden & Type-II



### End Cap For Expert Femur Nail

**Length:**

0mm, 5mm, 10mm and 15mm

**Available in:**

Stainless Steel and Titanium

**Color coding (only for Titanium) :**

Type-II For End Cap

**Features:**

- End Cap prevents ingrowth of hard & soft tissue which facilitates nail extraction.
- 0 mm End Cap sits flush with nail.
- End Cap with different option of length can extend nail height if nail is over inserted.
- Securely lock the most proximal oblique locking screw to create a fixed-angle construct.
- Cannulated.



### Ø4.8mm Locking Bolt, Self-Tapping, For Expert Femur Nail

**Length:**

26mm - 84mm (With 2mm difference), 85mm & 90mm

**Available in:**

Stainless Steel and Titanium

**Color Coding (only for Titanium) :**

Type-II for Ø4.8mm Locking Bolt

### Ø6.4mm Cannulated Anti-Rotation Screw, Self-Tapping, For Expert Femur Nail

**Length:**

60mm - 130mm (With 5mm difference)

**Available in:**

Stainless Steel and Titanium

**Color Coding (only for Titanium) :**

Type-II For Ø6.4mm Cannulated Anti-Rotation Screw

**Features:**

- Thread closer to screw head for better and improved stability
- Self Tapping
- Hex head
- Larger cross section for improved mechanical resistance.





## Entry Point

The entry point is a determinant factor for the entire operation, especially for the optimal nail position of the Expert Femur Nail in the medullary canal.



In AP view, the entry point is at the tip of the greater trochanter, approximately 5° lateral to the axis of the medullary canal.

In lateral view the entry point is in line with the axis of the intramedullary canal.



# Expert Femur Nail



## Stainless Steel

Dia	Length	Left	Right
Ø9mm	320mm	1459-9-320L	1459-9-320R
Ø9mm	340mm	1459-9-340L	1459-9-340R
Ø9mm	360mm	1459-9-360L	1459-9-360R
Ø9mm	380mm	1459-9-380L	1459-9-380R
Ø9mm	400mm	1459-9-400L	1459-9-400R
Ø9mm	420mm	1459-9-420L	1459-9-420R
Ø9mm	440mm	1459-9-440L	1459-9-440R
Ø10mm	320mm	1459-10-320L	1459-10-320R
Ø10mm	340mm	1459-10-340L	1459-10-340R
Ø10mm	360mm	1459-10-360L	1459-10-360R
Ø10mm	380mm	1459-10-380L	1459-10-380R
Ø10mm	400mm	1459-10-400L	1459-10-400R
Ø10mm	420mm	1459-10-420L	1459-10-420R
Ø10mm	440mm	1459-10-440L	1459-10-440R
Ø11mm	320mm	1459-11-320L	1459-11-320R
Ø11mm	340mm	1459-11-340L	1459-11-340R
Ø11mm	360mm	1459-11-360L	1459-11-360R
Ø11mm	380mm	1459-11-380L	1459-11-380R
Ø11mm	400mm	1459-11-400L	1459-11-400R
Ø11mm	420mm	1459-11-420L	1459-11-420R
Ø11mm	440mm	1459-11-440L	1459-11-440R
Ø12mm	320mm	1459-12-320L	1459-12-320R
Ø12mm	340mm	1459-12-340L	1459-12-340R
Ø12mm	360mm	1459-12-360L	1459-12-360R
Ø12mm	380mm	1459-12-380L	1459-12-380R
Ø12mm	400mm	1459-12-400L	1459-12-400R
Ø12mm	420mm	1459-12-420L	1459-12-420R
Ø12mm	440mm	1459-12-440L	1459-12-440R
Ø13mm	320mm	1459-13-320L	1459-13-320R
Ø13mm	340mm	1459-13-340L	1459-13-340R
Ø13mm	360mm	1459-13-360L	1459-13-360R
Ø13mm	380mm	1459-13-380L	1459-13-380R
Ø13mm	400mm	1459-13-400L	1459-13-400R
Ø13mm	420mm	1459-13-420L	1459-13-420R
Ø13mm	440mm	1459-13-440L	1459-13-440R

Right

Left





# Expert Femur Nail

**STERILE**

**Stainless Steel**

Dia	Length	Left	Right
Ø9mm	320mm	1459-9-320L-S	1459-9-320R-S
Ø9mm	340mm	1459-9-340L-S	1459-9-340R-S
Ø9mm	360mm	1459-9-360L-S	1459-9-360R-S
Ø9mm	380mm	1459-9-380L-S	1459-9-380R-S
Ø9mm	400mm	1459-9-400L-S	1459-9-400R-S
Ø9mm	420mm	1459-9-420L-S	1459-9-420R-S
Ø9mm	440mm	1459-9-440L-S	1459-9-440R-S
Ø10mm	320mm	1459-10-320L-S	1459-10-320R-S
Ø10mm	340mm	1459-10-340L-S	1459-10-340R-S
Ø10mm	360mm	1459-10-360L-S	1459-10-360R-S
Ø10mm	380mm	1459-10-380L-S	1459-10-380R-S
Ø10mm	400mm	1459-10-400L-S	1459-10-400R-S
Ø10mm	420mm	1459-10-420L-S	1459-10-420R-S
Ø10mm	440mm	1459-10-440L-S	1459-10-440R-S
Ø11mm	320mm	1459-11-320L-S	1459-11-320R-S
Ø11mm	340mm	1459-11-340L-S	1459-11-340R-S
Ø11mm	360mm	1459-11-360L-S	1459-11-360R-S
Ø11mm	380mm	1459-11-380L-S	1459-11-380R-S
Ø11mm	400mm	1459-11-400L-S	1459-11-400R-S
Ø11mm	420mm	1459-11-420L-S	1459-11-420R-S
Ø11mm	440mm	1459-11-440L-S	1459-11-440R-S
Ø12mm	320mm	1459-12-320L-S	1459-12-320R-S
Ø12mm	340mm	1459-12-340L-S	1459-12-340R-S
Ø12mm	360mm	1459-12-360L-S	1459-12-360R-S
Ø12mm	380mm	1459-12-380L-S	1459-12-380R-S
Ø12mm	400mm	1459-12-400L-S	1459-12-400R-S
Ø12mm	420mm	1459-12-420L-S	1459-12-420R-S
Ø12mm	440mm	1459-12-440L-S	1459-12-440R-S
Ø13mm	320mm	1459-13-320L-S	1459-13-320R-S
Ø13mm	340mm	1459-13-340L-S	1459-13-340R-S
Ø13mm	360mm	1459-13-360L-S	1459-13-360R-S
Ø13mm	380mm	1459-13-380L-S	1459-13-380R-S
Ø13mm	400mm	1459-13-400L-S	1459-13-400R-S
Ø13mm	420mm	1459-13-420L-S	1459-13-420R-S
Ø13mm	440mm	1459-13-440L-S	1459-13-440R-S

Right

Left





# Expert Femur Nail



## Titanium

Dia	Length	Left	Right
Ø9mm	320mm	TI-1459-9-320L	TI-1459-9-320R
Ø9mm	340mm	TI-1459-9-340L	TI-1459-9-340R
Ø9mm	360mm	TI-1459-9-360L	TI-1459-9-360R
Ø9mm	380mm	TI-1459-9-380L	TI-1459-9-380R
Ø9mm	400mm	TI-1459-9-400L	TI-1459-9-400R
Ø9mm	420mm	TI-1459-9-420L	TI-1459-9-420R
Ø9mm	440mm	TI-1459-9-440L	TI-1459-9-440R
Ø10mm	320mm	TI-1459-10-320L	TI-1459-10-320R
Ø10mm	340mm	TI-1459-10-340L	TI-1459-10-340R
Ø10mm	360mm	TI-1459-10-360L	TI-1459-10-360R
Ø10mm	380mm	TI-1459-10-380L	TI-1459-10-380R
Ø10mm	400mm	TI-1459-10-400L	TI-1459-10-400R
Ø10mm	420mm	TI-1459-10-420L	TI-1459-10-420R
Ø10mm	440mm	TI-1459-10-440L	TI-1459-10-440R
Ø11mm	320mm	TI-1459-11-320L	TI-1459-11-320R
Ø11mm	340mm	TI-1459-11-340L	TI-1459-11-340R
Ø11mm	360mm	TI-1459-11-360L	TI-1459-11-360R
Ø11mm	380mm	TI-1459-11-380L	TI-1459-11-380R
Ø11mm	400mm	TI-1459-11-400L	TI-1459-11-400R
Ø11mm	420mm	TI-1459-11-420L	TI-1459-11-420R
Ø11mm	440mm	TI-1459-11-440L	TI-1459-11-440R
Ø12mm	320mm	TI-1459-12-320L	TI-1459-12-320R
Ø12mm	340mm	TI-1459-12-340L	TI-1459-12-340R
Ø12mm	360mm	TI-1459-12-360L	TI-1459-12-360R
Ø12mm	380mm	TI-1459-12-380L	TI-1459-12-380R
Ø12mm	400mm	TI-1459-12-400L	TI-1459-12-400R
Ø12mm	420mm	TI-1459-12-420L	TI-1459-12-420R
Ø12mm	440mm	TI-1459-12-440L	TI-1459-12-440R
Ø13mm	320mm	TI-1459-13-320L	TI-1459-13-320R
Ø13mm	340mm	TI-1459-13-340L	TI-1459-13-340R
Ø13mm	360mm	TI-1459-13-360L	TI-1459-13-360R
Ø13mm	380mm	TI-1459-13-380L	TI-1459-13-380R
Ø13mm	400mm	TI-1459-13-400L	TI-1459-13-400R
Ø13mm	420mm	TI-1459-13-420L	TI-1459-13-420R
Ø13mm	440mm	TI-1459-13-440L	TI-1459-13-440R

Right

Left





# Expert Femur Nail

**STERILE**

**Titanium**

Dia	Length	Left	Right
Ø9mm	320mm	TI-1459-9-320L-S	TI-1459-9-320R-S
Ø9mm	340mm	TI-1459-9-340L-S	TI-1459-9-340R-S
Ø9mm	360mm	TI-1459-9-360L-S	TI-1459-9-360R-S
Ø9mm	380mm	TI-1459-9-380L-S	TI-1459-9-380R-S
Ø9mm	400mm	TI-1459-9-400L-S	TI-1459-9-400R-S
Ø9mm	420mm	TI-1459-9-420L-S	TI-1459-9-420R-S
Ø9mm	440mm	TI-1459-9-440L-S	TI-1459-9-440R-S
Ø10mm	320mm	TI-1459-10-320L-S	TI-1459-10-320R-S
Ø10mm	340mm	TI-1459-10-340L-S	TI-1459-10-340R-S
Ø10mm	360mm	TI-1459-10-360L-S	TI-1459-10-360R-S
Ø10mm	380mm	TI-1459-10-380L-S	TI-1459-10-380R-S
Ø10mm	400mm	TI-1459-10-400L-S	TI-1459-10-400R-S
Ø10mm	420mm	TI-1459-10-420L-S	TI-1459-10-420R-S
Ø10mm	440mm	TI-1459-10-440L-S	TI-1459-10-440R-S
Ø11mm	320mm	TI-1459-11-320L-S	TI-1459-11-320R-S
Ø11mm	340mm	TI-1459-11-340L-S	TI-1459-11-340R-S
Ø11mm	360mm	TI-1459-11-360L-S	TI-1459-11-360R-S
Ø11mm	380mm	TI-1459-11-380L-S	TI-1459-11-380R-S
Ø11mm	400mm	TI-1459-11-400L-S	TI-1459-11-400R-S
Ø11mm	420mm	TI-1459-11-420L-S	TI-1459-11-420R-S
Ø11mm	440mm	TI-1459-11-440L-S	TI-1459-11-440R-S
Ø12mm	320mm	TI-1459-12-320L-S	TI-1459-12-320R-S
Ø12mm	340mm	TI-1459-12-340L-S	TI-1459-12-340R-S
Ø12mm	360mm	TI-1459-12-360L-S	TI-1459-12-360R-S
Ø12mm	380mm	TI-1459-12-380L-S	TI-1459-12-380R-S
Ø12mm	400mm	TI-1459-12-400L-S	TI-1459-12-400R-S
Ø12mm	420mm	TI-1459-12-420L-S	TI-1459-12-420R-S
Ø12mm	440mm	TI-1459-12-440L-S	TI-1459-12-440R-S
Ø13mm	320mm	TI-1459-13-320L-S	TI-1459-13-320R-S
Ø13mm	340mm	TI-1459-13-340L-S	TI-1459-13-340R-S
Ø13mm	360mm	TI-1459-13-360L-S	TI-1459-13-360R-S
Ø13mm	380mm	TI-1459-13-380L-S	TI-1459-13-380R-S
Ø13mm	400mm	TI-1459-13-400L-S	TI-1459-13-400R-S
Ø13mm	420mm	TI-1459-13-420L-S	TI-1459-13-420R-S
Ø13mm	440mm	TI-1459-13-440L-S	TI-1459-13-440R-S

Right

Left



## End Caps For Expert Femur Nail



Stainless Steel	Titanium	Length
1459-01	TI-1459-01	0mm
1459-05	TI-1459-05	5mm
1459-10	TI-1459-10	10mm
1459-15	TI-1459-15	15mm
1459-20	TI-1459-20	20mm

Stainless Steel	Titanium	Length
1459-01-S	TI-1459-01-S	0mm
1459-05-S	TI-1459-05-S	5mm
1459-10-S	TI-1459-10-S	10mm
1459-15-S	TI-1459-15-S	15mm
1459-20-S	TI-1459-20-S	20mm



## Ø4.8mm Locking Bolt, Self-Tapping, For Expert Femur Nail



**STERILE**

Stainless Steel	Titanium	Length	Stainless Steel	Titanium	Length
1458-4.8-026	TI-1458-4.8-026	26mm	1458-4.8-026-S	TI-1458-4.8-026-S	26mm
1458-4.8-028	TI-1458-4.8-028	28mm	1458-4.8-028-S	TI-1458-4.8-028-S	28mm
1458-4.8-030	TI-1458-4.8-030	30mm	1458-4.8-030-S	TI-1458-4.8-030-S	30mm
1458-4.8-032	TI-1458-4.8-032	32mm	1458-4.8-032-S	TI-1458-4.8-032-S	32mm
1458-4.8-034	TI-1458-4.8-034	34mm	1458-4.8-034-S	TI-1458-4.8-034-S	34mm
1458-4.8-036	TI-1458-4.8-036	36mm	1458-4.8-036-S	TI-1458-4.8-036-S	36mm
1458-4.8-038	TI-1458-4.8-038	38mm	1458-4.8-038-S	TI-1458-4.8-038-S	38mm
1458-4.8-040	TI-1458-4.8-040	40mm	1458-4.8-040-S	TI-1458-4.8-040-S	40mm
1458-4.8-042	TI-1458-4.8-042	42mm	1458-4.8-042-S	TI-1458-4.8-042-S	42mm
1458-4.8-044	TI-1458-4.8-044	44mm	1458-4.8-044-S	TI-1458-4.8-044-S	44mm
1458-4.8-046	TI-1458-4.8-046	46mm	1458-4.8-046-S	TI-1458-4.8-046-S	46mm
1458-4.8-048	TI-1458-4.8-048	48mm	1458-4.8-048-S	TI-1458-4.8-048-S	48mm
1458-4.8-050	TI-1458-4.8-050	50mm	1458-4.8-050-S	TI-1458-4.8-050-S	50mm
1458-4.8-052	TI-1458-4.8-052	52mm	1458-4.8-052-S	TI-1458-4.8-052-S	52mm
1458-4.8-054	TI-1458-4.8-054	54mm	1458-4.8-054-S	TI-1458-4.8-054-S	54mm
1458-4.8-056	TI-1458-4.8-056	56mm	1458-4.8-056-S	TI-1458-4.8-056-S	56mm
1458-4.8-058	TI-1458-4.8-058	58mm	1458-4.8-058-S	TI-1458-4.8-058-S	58mm
1458-4.8-060	TI-1458-4.8-060	60mm	1458-4.8-060-S	TI-1458-4.8-060-S	60mm
1458-4.8-062	TI-1458-4.8-062	62mm	1458-4.8-062-S	TI-1458-4.8-062-S	62mm
1458-4.8-064	TI-1458-4.8-064	64mm	1458-4.8-064-S	TI-1458-4.8-064-S	64mm
1458-4.8-066	TI-1458-4.8-066	66mm	1458-4.8-066-S	TI-1458-4.8-066-S	66mm
1458-4.8-068	TI-1458-4.8-068	68mm	1458-4.8-068-S	TI-1458-4.8-068-S	68mm
1458-4.8-070	TI-1458-4.8-070	70mm	1458-4.8-070-S	TI-1458-4.8-070-S	70mm
1458-4.8-072	TI-1458-4.8-072	72mm	1458-4.8-072-S	TI-1458-4.8-072-S	72mm
1458-4.8-074	TI-1458-4.8-074	74mm	1458-4.8-074-S	TI-1458-4.8-074-S	74mm
1458-4.8-076	TI-1458-4.8-076	76mm	1458-4.8-076-S	TI-1458-4.8-076-S	76mm
1458-4.8-078	TI-1458-4.8-078	78mm	1458-4.8-078-S	TI-1458-4.8-078-S	78mm
1458-4.8-080	TI-1458-4.8-080	80mm	1458-4.8-080-S	TI-1458-4.8-080-S	80mm
1458-4.8-082	TI-1458-4.8-082	82mm	1458-4.8-082-S	TI-1458-4.8-082-S	82mm
1458-4.8-084	TI-1458-4.8-084	84mm	1458-4.8-084-S	TI-1458-4.8-084-S	84mm
1458-4.8-085	TI-1458-4.8-085	85mm	1458-4.8-085-S	TI-1458-4.8-085-S	85mm
1458-4.8-090	TI-1458-4.8-090	90mm	1458-4.8-090-S	TI-1458-4.8-090-S	90mm



# Ø6.4mm Cannulated Anti -Rotation Screw, Self-Tapping, For Expert Femur Nail



**STERILE**

Stainless Steel	Titanium	Length
1459-060	TI-1459-060	60mm
1459-065	TI-1459-065	65mm
1459-070	TI-1459-070	70mm
1459-075	TI-1459-075	75mm
1459-080	TI-1459-080	80mm
1459-085	TI-1459-085	85mm
1459-090	TI-1459-090	90mm
1459-095	TI-1459-095	95mm
1459-100	TI-1459-100	100mm
1459-105	TI-1459-105	105mm
1459-110	TI-1459-110	110mm
1459-115	TI-1459-115	115mm
1459-120	TI-1459-120	120mm
1459-125	TI-1459-125	125mm
1459-130	TI-1459-130	130mm

Stainless Steel	Titanium	Length
1459-060-S	TI-1459-060-S	60mm
1459-065-S	TI-1459-065-S	65mm
1459-070-S	TI-1459-070-S	70mm
1459-075-S	TI-1459-075-S	75mm
1459-080-S	TI-1459-080-S	80mm
1459-085-S	TI-1459-085-S	85mm
1459-090-S	TI-1459-090-S	90mm
1459-095-S	TI-1459-095-S	95mm
1459-100-S	TI-1459-100-S	100mm
1459-105-S	TI-1459-105-S	105mm
1459-110-S	TI-1459-110-S	110mm
1459-115-S	TI-1459-115-S	115mm
1459-120-S	TI-1459-120-S	120mm
1459-125-S	TI-1459-125-S	125mm
1459-130-S	TI-1459-130-S	130mm

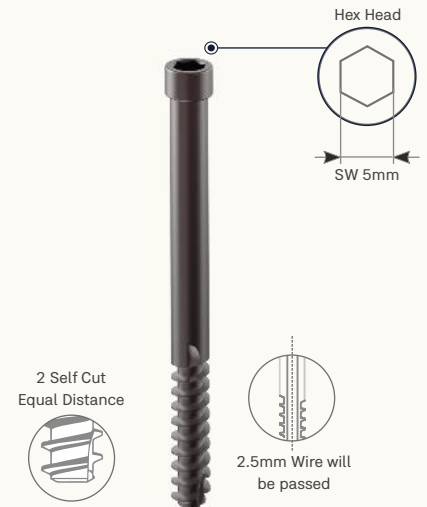



## Optional

### Ø4.8mm Locking Bolt, Self-Tapping, For Expert Femur Nail, Stainless Steel- Old Design



Stainless Steel	Titanium	Length
1458-4.8-026-OD	TI-1458-4.8-026-OD	26mm
1458-4.8-028-OD	TI-1458-4.8-028-OD	28mm
1458-4.8-030-OD	TI-1458-4.8-030-OD	30mm
1458-4.8-032-OD	TI-1458-4.8-032-OD	32mm
1458-4.8-034-OD	TI-1458-4.8-034-OD	34mm
1458-4.8-036-OD	TI-1458-4.8-036-OD	36mm
1458-4.8-038-OD	TI-1458-4.8-038-OD	38mm
1458-4.8-040-OD	TI-1458-4.8-040-OD	40mm
1458-4.8-042-OD	TI-1458-4.8-042-OD	42mm
1458-4.8-044-OD	TI-1458-4.8-044-OD	44mm
1458-4.8-046-OD	TI-1458-4.8-046-OD	46mm
1458-4.8-048-OD	TI-1458-4.8-048-OD	48mm
1458-4.8-050-OD	TI-1458-4.8-050-OD	50mm
1458-4.8-052-OD	TI-1458-4.8-052-OD	52mm
1458-4.8-054-OD	TI-1458-4.8-054-OD	54mm
1458-4.8-056-OD	TI-1458-4.8-056-OD	56mm
1458-4.8-058-OD	TI-1458-4.8-058-OD	58mm
1458-4.8-060-OD	TI-1458-4.8-060-OD	60mm
1458-4.8-062-OD	TI-1458-4.8-062-OD	62mm
1458-4.8-064-OD	TI-1458-4.8-064-OD	64mm
1458-4.8-066-OD	TI-1458-4.8-066-OD	66mm
1458-4.8-068-OD	TI-1458-4.8-068-OD	68mm
1458-4.8-070-OD	TI-1458-4.8-070-OD	70mm
1458-4.8-072-OD	TI-1458-4.8-072-OD	72mm
1458-4.8-074-OD	TI-1458-4.8-074-OD	74mm
1458-4.8-076-OD	TI-1458-4.8-076-OD	76mm
1458-4.8-078-OD	TI-1458-4.8-078-OD	78mm
1458-4.8-080-OD	TI-1458-4.8-080-OD	80mm
1458-4.8-082-OD	TI-1458-4.8-082-OD	82mm
1458-4.8-084-OD	TI-1458-4.8-084-OD	84mm
1458-4.8-085-OD	TI-1458-4.8-085-OD	85mm
1458-4.8-090-OD	TI-1458-4.8-090-OD	90mm





1-014L

Implant Box for Expert Femur Nail (Left)

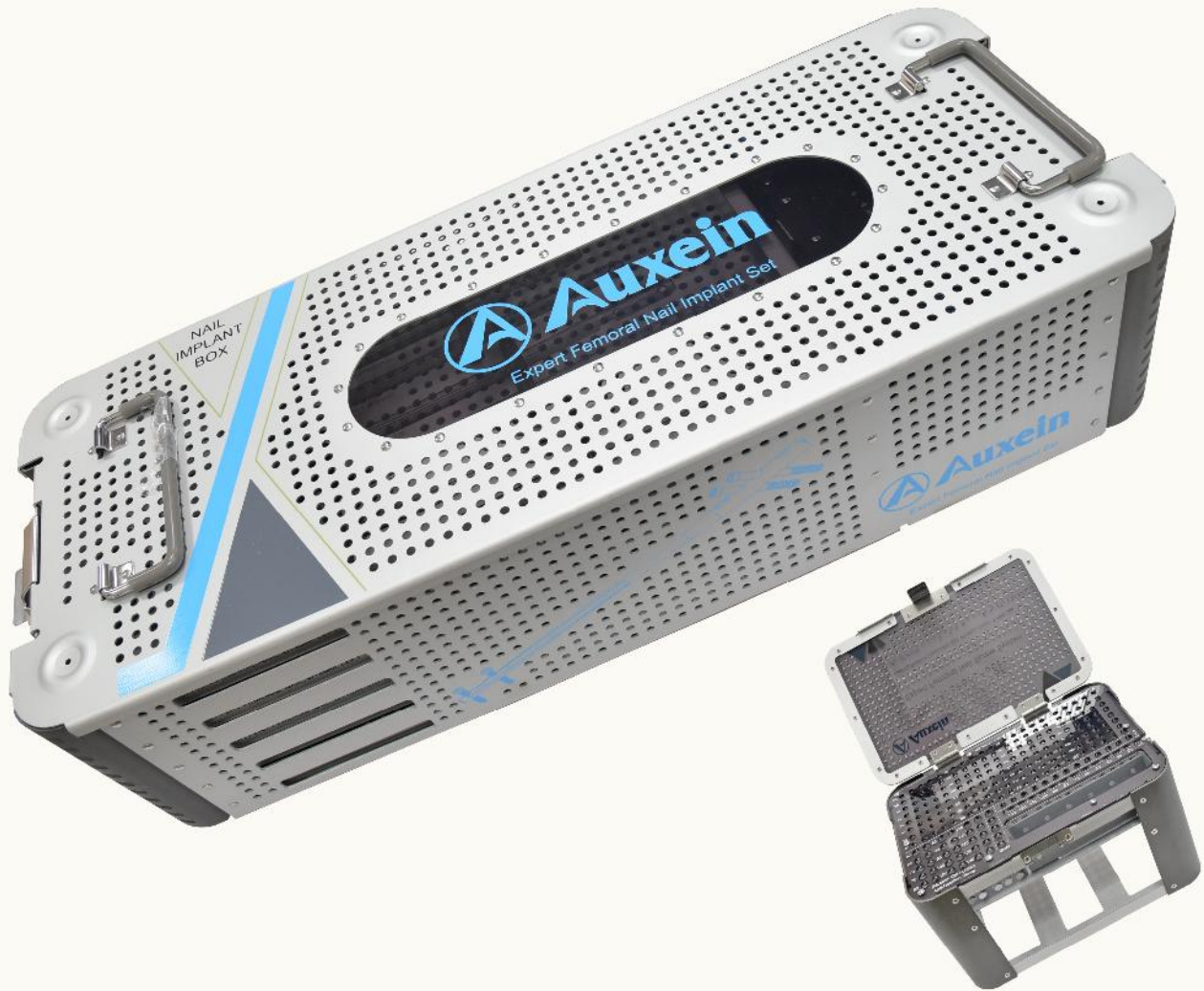



**Tray 1**

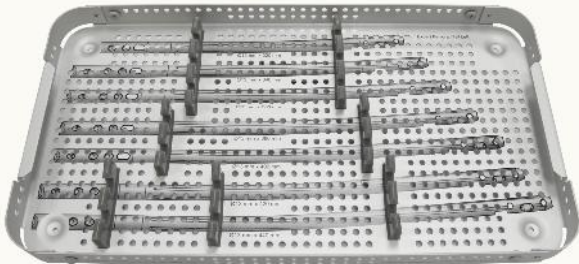

Dia	Length	Qty
Ø9mm	320mm to 440mm	1pcs

*Stainless Steel or Titanium Implants can be placed as per requirement*

**Tray 2**

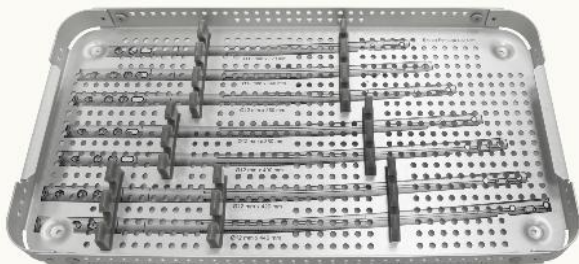

Dia	Length	Qty
Ø10mm	320mm to 440mm	1pcs

*Stainless Steel or Titanium Implants can be placed as per requirement*

**Tray 3**

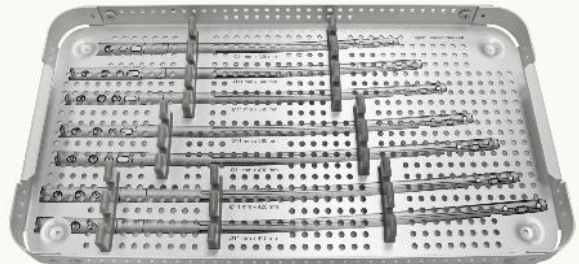

Dia	Length	Qty
Ø11mm	320mm to 440mm	1pcs

*Stainless Steel or Titanium Implants can be placed as per requirement*

**Tray 4**

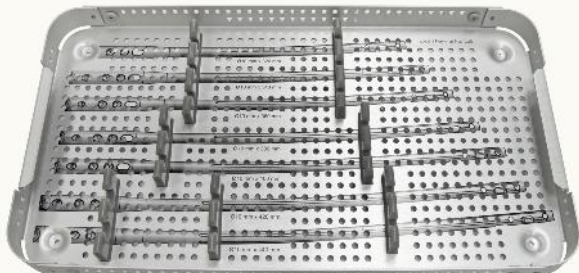

Dia	Length	Qty
Ø12mm	320mm to 440mm	1pcs

*Stainless Steel or Titanium Implants can be placed as per requirement*

**Tray 5**

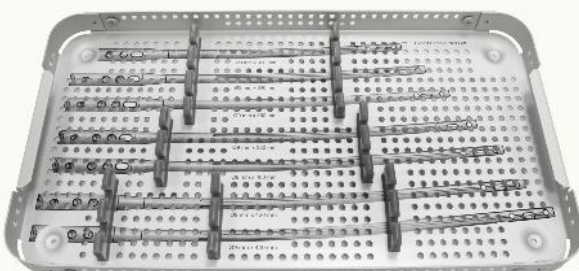

Dia	Length	Qty
Ø13mm	320mm to 440mm	1pcs

*Stainless Steel or Titanium Implants can be placed as per requirement*



## Ø4.8mm Locking Bolt, Self-Tapping, for Expert Femur Nail

Dia	Length	Qty
Ø4.8mm	26mm to 90mm	5pcs

*Stainless Steel or Titanium Implants can be placed as per requirement*

## Ø6.4mm Cannulated Anti-Rotation Screw, Self-Tapping, for Expert Femur Nail

Dia	Length	Qty
Ø6.4mm	60mm to 130mm	2pcs

*Stainless Steel or Titanium Implants can be placed as per requirement*

## End Caps For Expert Femur Nail

Dia	Length	Qty
Ø11mm	0mm to 20mm	2pcs

*Stainless Steel or Titanium Implants can be placed as per requirement*



1-014R

Implant Box for Expert Femur Nail (Right)





**Tray 1**

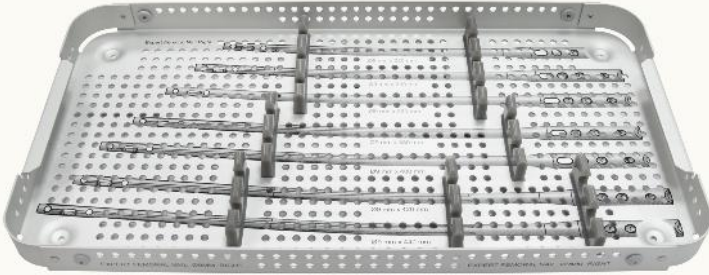

Dia	Length	Qty
Ø9mm	320mm to 440mm	1pcs

*Stainless Steel or Titanium Implants can be placed as per requirement*

**Tray 2**

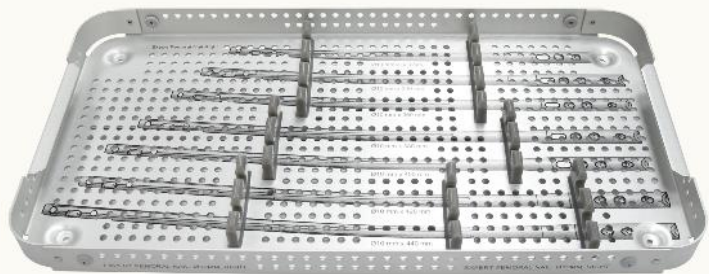

Dia	Length	Qty
Ø10mm	320mm to 440mm	1pcs

*Stainless Steel or Titanium Implants can be placed as per requirement*

**Tray 3**

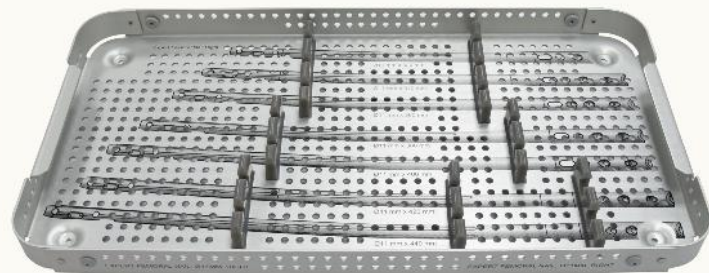

Dia	Length	Qty
Ø11mm	320mm to 440mm	1pcs

*Stainless Steel or Titanium Implants can be placed as per requirement*

**Tray 4**

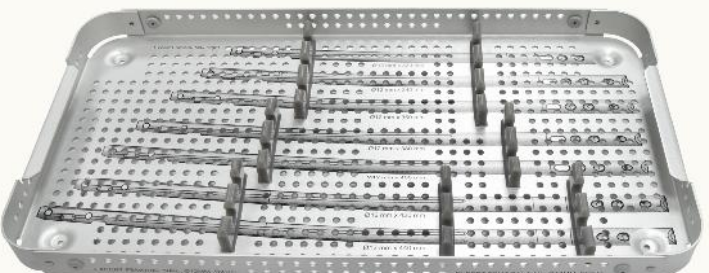

Dia	Length	Qty
Ø12mm	320mm to 440mm	1pcs

*Stainless Steel or Titanium Implants can be placed as per requirement*

**Tray 5**

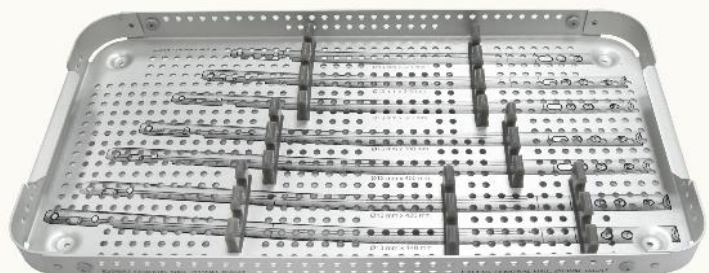

Dia	Length	Qty
Ø13mm	320mm to 440mm	1pcs

*Stainless Steel or Titanium Implants can be placed as per requirement*



## Ø4.8mm Locking Bolt, Self-Tapping, for Expert Femur Nail

Dia	Length	Qty
Ø4.8mm	26mm to 90mm	5pcs

*Stainless Steel or Titanium Implants can be placed as per requirement*

## Ø6.4mm Cannulated Anti -Rotation Screw, Self-Tapping, for Expert Femur Nail

Dia	Length	Qty
Ø6.4mm	60mm to 130mm	2pcs

*Stainless Steel or Titanium Implants can be placed as per requirement*

## End Caps For Expert Femur Nail

Dia	Length	Qty
Ø11mm	0mm to 20mm	2pcs

*Stainless Steel or Titanium Implants can be placed as per requirement*



# INSTRUMENTS



1459-001

Cannulated Awl for Expert Femur Nail



1459-002

Entry Reamer Ø14.3mm for Expert Femur Nail



1459-003

T-Handle with Quick Coupling for Entry Reamer - Expert Femur Nail



1459-004

Guide Wire With Ball Tip Ø2.5/3.65mm x Length 1000mm - Nitinol, for Expert Femur Nail



1459-062

Guide Wire Without Ball Tip Ø2.5mm x Length 1000mm - Nitinol, for Expert Femur Nail



1459-005

Insertion Handle for Expert Femur Nail



1459-006

Flexible Reamer Shaft (AO Connection) for Expert Femur Nail



1459-007

Reduction Rod for Expert Femur Nail

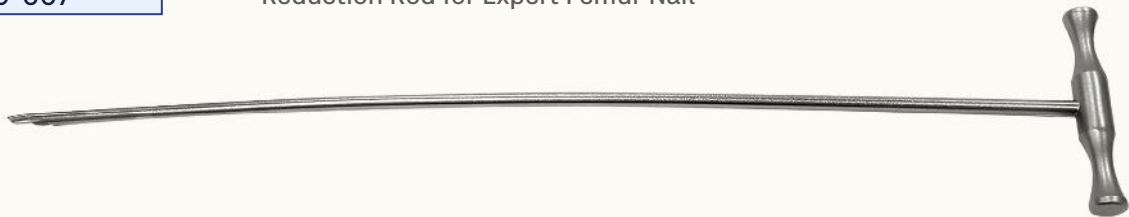

**Reamer Head For Expert Femur Nail**

Code	Dia
1459-008	Ø8.5mm
1459-009	Ø9mm
1459-010	Ø9.5mm
1459-011	Ø10mm
1459-012	Ø10.5mm
1459-013	Ø11mm

Code	Dia
1459-014	Ø11.5mm
1459-015	Ø12mm
1459-016	Ø12.5mm
1459-017	Ø13mm
1459-018	Ø13.5mm
1459-019	Ø14mm



1459-020

Nail Holding Bolt for Expert Femur Nail

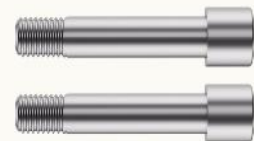

1459-021

Long Screwdriver with T-Handle, Hex 5mm, for Expert Femur Nail





1459-022

Sliding Hammer for Expert Femur Nail



1459-023

Proximal Aiming Bar for Expert Femur Nail



1459-024

Locking Bolt For Proximal Aiming Bar - Expert Femur Nail



1459-025

Allen Key, Hex 5mm for Expert Femur Nail



1459-026

Proximal Aiming Device for Expert Femur Nail



1459-027

Distal Aiming Bar for Expert Femur Nail



1459-028

Locking Bolt for Distal Aiming Bar - Expert Femur Nail



1459-029

Distal Targeting Device for Expert Femur Nail



1459-030

Outer Drill Sleeve 10/8.1mm for Distal Targeting Device - Expert Femur Nail



1459-031

Trocar for Sleeve 8.1mm for Distal Targeting Device- Expert Femur Nail



1459-032

Drill Sleeve 8.1/5.2mm for Positioning Rod - Expert Femur Nail



1459-033

Drill Bit Plain Shank/Jacob Chuck End Ø5.2mm x Length 250mm for Expert Femur Nail





1459-034

Ø5.2mm T-Handle Drill Bit with Flat End for Expert Femur Nail



1459-035

Positioning Rod 8.1/5.2mm for Expert Femur Nail



1459-036

Stabilizing Device for Expert Femur Nail



1459-037

Outer Drill Sleeve 11/8.2mm for Expert Femur Nail



1459-038

Trocar Sleeve Ø8.2/2.5mm for Expert Femur Nail

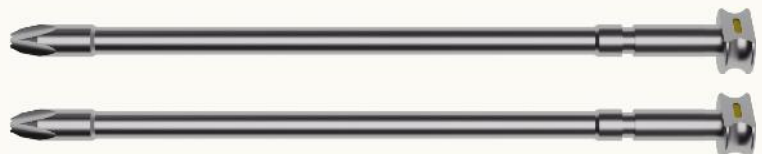

1459-039

Trocar Ø2.5mm for Expert Femur Nail



1459-040

Drill Sleeve 8/4.4mm for Expert Femur Nail

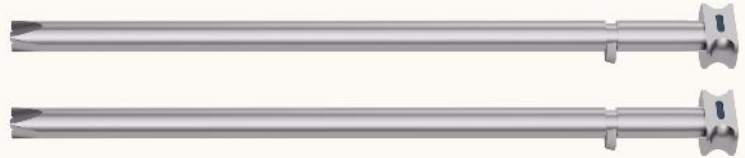

1459-041

Trocar Ø4.3mm for Expert Femur Nail



1459-042

Drill Bit Plain Shank/Jacob Chuck End Ø4.3mm x Length 300mm for Expert Femur Nail



1459-061

Stopper for Ø4.3mm Drill Bit - Expert Femur Nail



7-118-01

Allen Key, Hex 3mm for Expert Femur Nail



1459-043

Depth Gauge measuring upto 90mm for Ø4.8mm Locking Bolt - Expert Femur Nail





1459-044

Screwdriver with T-Handle, Hex 3.5mm for Ø4.8mm Locking Bolt - Expert Femur Nail



1459-045

Universal Screwdriver, Hex 6.5mm, Ball Tip for Nail Holding Bolt- Expert Femur Nail



1459-046

Distal Bolt, Hex 5mm for Distal Targeting Device - Expert Femur Nail



1459-047

Guide Wire with Threaded Tip Ø2.5mm x Thread Length 10mm x Length 338mm



1459-048

Guide Wire, Ø2.5mm x Length 338mm



1459-049

Direct Measuring Device, Length upto 120mm, for Expert Femur Nail



1459-050-1

Tissue Protector for Expert Femur Nail

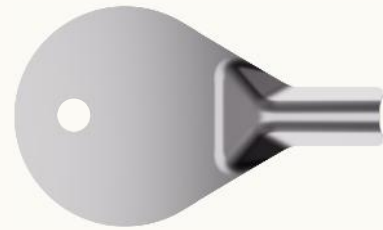

1459-051

Cannulated Step Drill Bit for Anti-Rotation Screw - Expert Femur Nail



1459-051-1

Stopper for Step Drill Bit - Expert Femur Nail



1459-053

Protection Sleeve 17/14.5mm for Expert Femur Nail



1459-052

Guide Sleeve 14.3/3.2mm for Protection Sleeve - Expert Femur Nail



1459-054

Impactor - Extractor Rod for Expert Femur Nail





1459-055-1

Guide Wire Holder for Expert Femur Nail

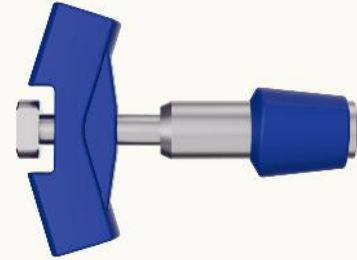

1459-056

Distal Screw Device (Static/ Dynamic Locking) for Expert Femur Nail



1459-057

Combination Wrench 11mm for Expert Femur Nail



1459-058

Connecting Rod - Impactor for Expert Femur Nail



1459-058-1

Connecting Block for Connecting Rod - Expert Femur Nail

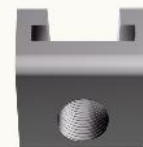

1459-059

Compression Bolt Ø4mm for Expert Femur Nail



1459-060-1

Guide Pin, Ø3.2mm x Length 480mm



1459-063

Radiographic Ruler for Expert Femur Nail



1459-064

Depth Gauge measuring upto 100mm for Expert Femur Nail



1459-067

Curved Awl- Ø9.5-Ø5.6mm for Expert Femur Nail



7-010-02

Medullary Exchange Tube



7-010-03

T-Handle for Flexible Reamer (AO Connection)





1459-065T

Instrument Trays for Expert Femur Nailing Instrument Set

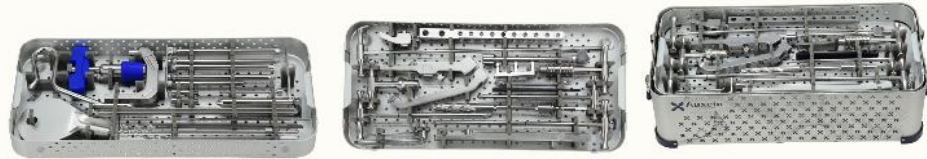

1459-066

Container with PPSU Lid for Expert Femur Nailing Instrument Set



## Optional Instruments

1459-004S

Guide Wire With Ball Tip  $\varnothing 2.5/3.65\text{mm}$  x Length 1000mm -Stainless Steel, for Expert Femur Nail



1459-062S

Guide Wire Without Ball Tip  $\varnothing 2.5\text{mm}$  x Length 1000mm -Stainless Steel, for Expert Femur Nail



**INS-1459 : Expert Femur Nailing Instrument Set**

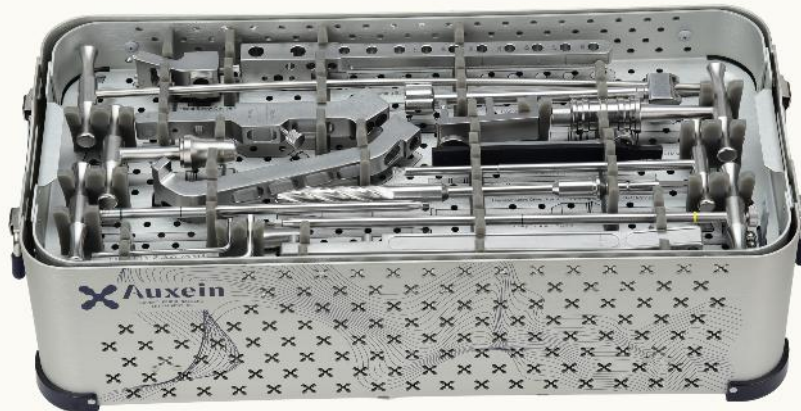
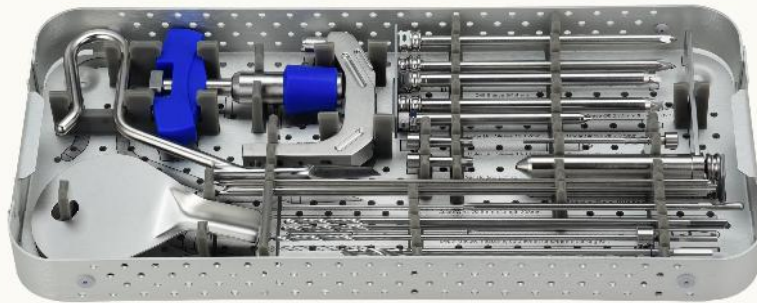
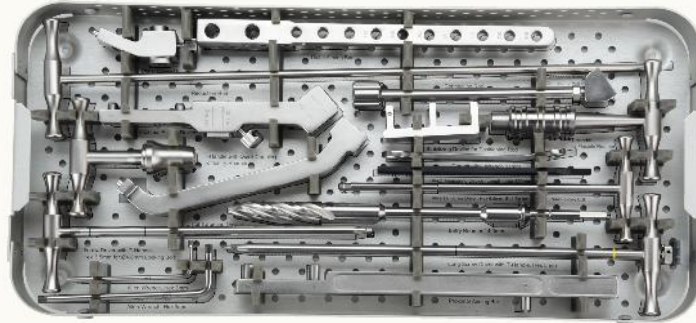



# ORDER INFORMATION

INS-1459

## Expert Femur Nailing Instrument Set

Code	Set Consisting Of	Unit
1459-001	Cannulated Awl for Expert Femur Nail	1
1459-002	Entry Reamer Ø14.3mm for Expert Femur Nail	1
1459-003	T-Handle with Quick Coupling for Entry Reamer - Expert Femur Nail	1
1459-004	Guide Wire With Ball Tip Ø2.5/3.65mm x Length 1000mm - Nitinol	1
1459-062	Guide Wire Without Ball Tip Ø2.5mm x Length 1000mm - Nitinol	1
1459-005	Insertion Handle for Expert Femur Nail	1
1459-006	Flexible Reamer Shaft (AO Connection) for Expert Femur Nail	2
1459-007	Reduction Rod for Expert Femur Nail	1
1459-008	Reamer Head, Ø8.5mm for Expert Femur Nail	1
1459-009	Reamer Head, Ø9.0mm for Expert Femur Nail	1
1459-010	Reamer Head, Ø9.5mm for Expert Femur Nail	1
1459-011	Reamer Head, Ø10.0mm for Expert Femur Nail	1
1459-012	Reamer Head, Ø10.5mm for Expert Femur Nail	1
1459-013	Reamer Head, Ø11.0mm for Expert Femur Nail	1
1459-014	Reamer Head, Ø11.5mm for Expert Femur Nail	1
1459-015	Reamer Head, Ø12.0mm for Expert Femur Nail	1
1459-016	Reamer Head, Ø12.5mm for Expert Femur Nail	1
1459-017	Reamer Head, Ø13.0mm for Expert Femur Nail	1
1459-018	Reamer Head, Ø13.5mm for Expert Femur Nail	1
1459-019	Reamer Head, Ø14.0mm for Expert Femur Nail	1
1459-020	Nail Holding Bolt for Expert Femur Nail	2
1459-021	Long Screwdriver with T-Handle, Hex 5mm, for Expert Femur Nail	1
1459-022	Sliding Hammer for Expert Femur Nail	1
1459-023	Proximal Aiming Bar for Expert Femur Nail	1
1459-024	Locking Bolt For Proximal Aiming Bar - Expert Femur Nail	1
1459-025	Allen Key, Hex 5mm for Expert Femur Nail	1
1459-026	Proximal Aiming Device for Expert Femur Nail	1
1459-027	Distal Aiming Bar for Expert Femur Nail	1
1459-028	Locking Bolt for Distal Aiming Bar - Expert Femur Nail	1
1459-029	Distal Targeting Device for Expert Femur Nail	1
1459-030	Outer Drill Sleeve 10/8.1mm for Distal Targeting Device - Expert Femur Nail	1
1459-031	Trocar for Sleeve 8.1mm for Distal Targeting Device- Expert Femur Nail	1
1459-032	Drill Sleeve 8.1/5.2mm for Positioning Rod - Expert Femur Nail	1
1459-033	Drill Bit Plain Shank/Jacob Chuck End Ø5.2mm x Length 250mm	1
1459-034	Ø5.2mm T-Handle Drill Bit with Flat End for Expert Femur Nail	1
1459-035	Positioning Rod 8.1/5.2mm for Expert Femur Nail	1
1459-036	Stabilizing Device for Expert Femur Nail	1
1459-037	Outer Drill Sleeve 11/8.2mm for Expert Femur Nail	2



Code	Set Consisting Of	Unit
1459-038	Trocar Sleeve Ø8.2/2.5mm for Expert Femur Nail	2
1459-039	Trocar Ø2.5mm for Expert Femur Nail	1
1459-040	Drill Sleeve 8/4.4mm for Expert Femur Nail	2
1459-041	Trocar Ø4.3mm for Expert Femur Nail	1
1459-042	Drill Bit Plain Shank/Jacob Chuck End Ø4.3mm x Length 300mm for Expert Femur Nail	3
1459-061	Stopper for Ø4.3mm Drill Bit - Expert Femur Nail	1
7-118-01	Allen Key, Hex 3mm for Expert Femur Nail	1
1459-043	Depth Gauge measuring upto 90mm for Ø4.8mm Locking Bolt - Expert Femur Nail	1
1459-044	Screwdriver with T-Handle, Hex 3.5mm for Ø4.8mm Locking Bolt - Expert Femur Nail	1
1459-045	Universal Screwdriver, Hex 6.5mm, Ball Tip for Nail Holding Bolt- Expert Femur Nail	1
1459-046	Distal Bolt, Hex 5mm for Distal Targeting Device - Expert Femur Nail	2
1459-047	Guide Wire with Threaded Tip Ø2.5mm x Thread Length 10mm x Length 338mm	3
1459-048	Guide Wire, Ø2.5mm x Length 338mm	3
1459-049	Direct Measuring Device, Length upto 120mm, for Expert Femur Nail	1
1459-050-1	Tissue Protector for Expert Femur Nail	1
1459-051	Cannulated Step Drill Bit for Anti-Rotation Screw - Expert Femur Nail	1
1459-051-1	Stopper for Step Drill Bit - Expert Femur Nail	1
1459-053	Protection Sleeve 17/14.5mm for Expert Femur Nail	1
1459-052	Guide Sleeve 14.3/3.2mm for Protection Sleeve - Expert Femur Nail	1
1459-054	Impactor - Extractor Rod for Expert Femur Nail	1
1459-055-1	Guide Wire Holder for Expert Femur Nail	1
1459-056	Distal Screw Device (Static/ Dynamic Locking) for Expert Femur Nail	1
1459-057	Combination Wrench 11mm for Expert Femur Nail	1
1459-058	Connecting Rod - Impactor for Expert Femur Nail	1
1459-058-1	Connecting Block for Connecting Rod - Expert Femur Nail	1
1459-059	Compression Bolt Ø4mm for Expert Femur Nail	1
1459-060-1	Guide Pin, Ø3.2mm x Length 480mm	2
1459-063	Radiographic Ruler for Expert Femur Nail	1
1459-064	Depth Gauge measuring upto 100mm for Expert Femur Nail	1
1459-067	Curved Awl- Ø9.5-Ø5.6mm for Expert Femur Nail	1
7-010-02	Medullary Exchange Tube	1
7-010-03	T-Handle for Flexible Reamer (AO Connection)	1
1459-065T	Instrument Trays for Expert Femur Nailing Instrument Set	3
1459-066	Container with PPSU Lid for Expert Femur Nailing Instrument Set	1
	<b>Optional Instruments</b>	
1459-004S	Guide Wire With Ball Tip Ø2.5/3.65mm x Length 1000mm -Stainless Steel, for Expert Femur Nail	
1459-062S	Guide Wire Without Ball Tip Ø2.5mm x Length 1000mm -Stainless Steel, for Expert Femur Nail	



## **EXPERT FEMUR NAILING SYSTEM**

The content of this catalogue is intended for healthcare professionals only. All product information, illustrations, descriptions, and specifications provided here are for general informational purposes and are subject to change without notice. Auxein Medical Pvt. Ltd. reserves the right to improve or discontinue products at any time without prior notification.

This document does not constitute medical advice. Surgeons and medical practitioners must exercise their own professional judgment when using any medical devices or instruments, including those provided by Auxein.

### **INTENDED USE**

The implants and instruments in this catalogue are intended for use by qualified orthopedic trauma surgeons trained in fracture fixation and intramedullary nailing procedures. Improper selection of the implant, incorrect surgical technique, misuse, or insufficient surgical experience may result in implant failure or other complications.

### **REGULATORY COMPLIANCE CERTIFIED**

CE Approved (EUMDR-2017/745)

USFDA 510(k)

ISO 13485:2016

CDSCO

MDSAP

### **INTELLECTUAL PROPERTY**

All trademarks, trade names, brand names, product names, and logos mentioned in this catalogue are the property of Auxein Medical Pvt. Ltd. Unauthorized use or reproduction is strictly prohibited.

V1-2026





SCAN TO KNOW MORE

**INDIA**  
**AUXEIN MEDICAL PVT.LTD.**

PLOT NO. 168-169-170, PHASE-4,  
KUNDLI INDUSTRIAL AREA,  
HSIIDC, SECTOR-57,  
SONEPAT-131028, HARYANA  
TEL: +91 99106 43638  
FAX: +91 86077 70197  
EMAIL: INFO@AUXEIN.COM

**MÉXICO**  
**AUXEIN MÉXICO, S.A DE CV**

TEPIC 39 INT 801, COLONIA  
ROMA SUR,  
ALCADÍA CUAUHTÉMOC, CDMX  
MÉXICO, C.P 06760  
TEL: +521 55 7261 0318  
EMAIL: INFO@AUXEIN.MX

**USA**  
**AUXEIN INC.**

1500 NW 89TH COURT,  
SUITE 107-108  
DORAL, FLORIDA 33172  
TEL. +1 305 395 6062  
E FAX: +1 305 395 62 62  
EMAIL: USOFFICE@AUXEIN.COM

**DUBAI UAE**  
**AUXEIN MEDICAL**

TRADING FZCO OUD METHA  
OFFICES BUILDING B BLOCK,  
1ST FLOOR, OFFICE NO.26,  
NEAR HEALTHCARE CITY,  
PO BOX-25572  
TEL. +971 438 71333  
EMAIL: INFO@AUXEIN.COM

[WWW.AUXEIN.COM](http://WWW.AUXEIN.COM)